

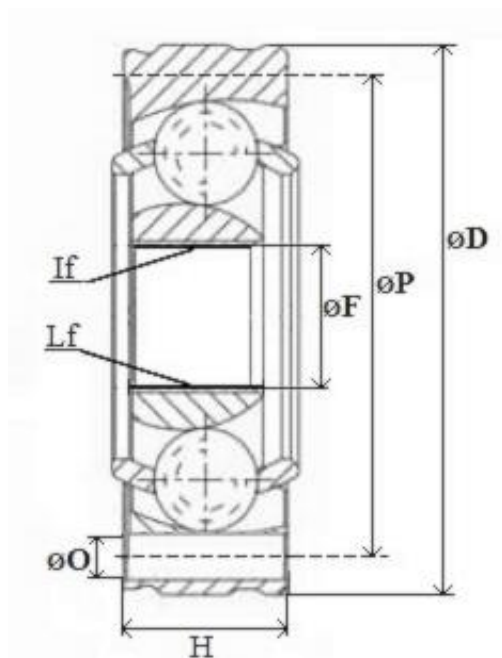



ШРУСЫ КАРДАНЫХ ВАЛОВ









Шрус карданного вала	Кол-во зубов I_f	Наружный диаметр $\varnothing D$	Ширина шруса H	Величина на зуб L_f	\varnothing зуб $\varnothing F$	\varnothing отверстий $\varnothing O$	\varnothing по отверстиям $\varnothing P$	\varnothing под трубу	Каталожный номер
	19		64,7	20	22,7		91	50,8	RN335Y
	19	80	24,3	19,5	22,3	8	67,2	---	HO805
	19	86	22,5	25,7	22,65	8	74	---	ME735
	20	68,5	101			---	---	72	RN760Y

Шрус карданного вала	Кол-во зубов If	Наружный диаметр ØD	Ширина шруса H	Величи на зубов Lf	Ø зубов øF	Ø отверстий øO	Ø по отверстиям øP	Ø под трубу	Каталожный номер
	20	86	20,9	21,5	27,8	8	74	---	VO86/ME734
	21	86	26	26	24,1	8	74	---	CH077B
	21	86	27,5	21,3	23,7	8	73,8	---	SK305-E
	22	86	21	22	25	8	74	50	VO86Y
	22	фланец 115	130	--	---	4x10	DIN 73		CVJ002
	23	94	52,6	22	27	8	80	---	MI331
	23	94	52,6	22	27	8	80		MI331Y

Шрус карданного вала	Кол-во зубов If	Наружный диаметр ØD	Ширина шруса H	Величина на зуб Lf	Ø зубов øF	Ø отверстий øO	Ø по отверстиям øP	Ø под трубу	Каталожный номер
	24	78	23,4	21	20,5	8	66	---	VO78/ME733
	24	78	23,4	21,5	20,5	8	65,5	60 x 2	VO78Y
	24	93,5	32	23,9	27	8	80	---	CVJ009
	24	94	32	29	26,98	8	80	---	VO701
	24	94	32	26,5	26,7	8	78	---	VO701-E
	24	94	32	24	27	10	80	---	VO701-KS
	24	94	33	29	26,98	8	78	---	VO702-E

Шрус карданного вала	Кол-во зубов If	Наружный диаметр ØD	Ширина шруса H	Величи на зубов Lf	Ø зубов øF	Ø отверстий øO	Ø по отверстиям øP	Ø под трубу	Каталожный номер
	25	100	29	---	---	10	86	47,5	IA007Y
	25	100	29,5	---	---	10	86	---	IA006
	25	100	29,5	---	---	10	86	66,5	IA006Y
	25	100	30	24	27,8	8	86	---	ME807
	25	100	30	24	27,8	8	86	---	ME807Y
	25	100	30	24,2	27,6	8	86	--	ME807-E
	25	100	30	24	---	8,5	---	---	ME840



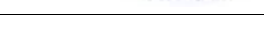

Шрус карданного вала	Кол-во зубов If	Наружный диаметр ØD	Ширина шруса H	Величи на зубов Lf	Ø зубов øF	Ø отверстий øO	Ø по отверстиям øP	Ø под трубу	Каталожный номер
	25	100	30	23	28	6x8	86		CVJ001
	25	100	31,7	33,1	27,5	8	86	---	CVJ018
	25	100	32	28	27,6	8	86	---	BM305
	25	100	32	29	27,8	10	86	---	BM305-E
	25	100	40	40,5	28	8	86	---	CH501-E
	25	100	40	40,5	28	8	86	32	CH501Y
	25	84	26	28,8	20,7	8	71,5	---	AD305-E

Шрус карданного вала	Кол-во зубов If	Наружный диаметр ØD	Ширина шруса H	Величи на зубов Lf	Ø зубов øF	Ø отверстий øO	Ø по отверстиям øP	Ø под трубу	Каталожный номер
	25	86	29	23	28,1	---	---	70 x 2	AD351MS
	25	86	29	23	28,1	---	---	70 x 2/ 60 x 2	AD351MSY
	25	88	50	25	28	---	---	60	AD353MS
	25	95	70			8		---	RV100
	25	95	70			8		56,7	RV100Y
	26	100	32	27,7	29	8	81	---	ME262
	26	100	32	---	---	8	86	60,4	ME262Y

Шрус карданного вала	Кол-во зубов If	Наружный диаметр ØD	Ширина шруса H	Величи на зубов Lf	Ø зубов øF	Ø отверстий øO	Ø по отверстиям øP	Ø под трубу	Каталожный номер
	26	100	42	33,3	29	8	81	---	HY318
	26	100	42,1	38,8	28,3	8	86	---	CVJ011
	26	107	35	32,2	28,8	8	91	---	VW712
	26	107	35	32	28,8	8	91	---	VW712-E
	28	108	28						ME789
	28	108	28	27,4	31,2	10	94	---	VW022
	28	108	32	---	---	10	95	60,5	IA005Y

Шрус карданного вала	Кол-во зубов If	Наружный диаметр ØD	Ширина шруса H	Величина на зуб Lf	Ø зубов øF	Ø отверстий øO	Ø по отверстиям øP	Ø под трубу	Каталожный номер
	28	108	40	27,7	31,2	10	94	---	PS701
	28	108/105,7	32	28	31,3	6x10	93,8		ME754
	28	110	38	26,3	29,5	10	91	---	CVJ013
	28	110	38	26,4	29,3	10	91	---	CVJ013
	28	114	33,7	36,9	29,5	11	98	---	CVJ013B
	30	100	---	---	---	10	86	47,7	MI330Y
	30	100	37	37,5	24,9	8	85,6	---	CVJ008

Шрус карданного вала	Кол-во зубов If	Наружный диаметр ØD	Ширина шруса H	Величина на зуб Lf	Ø зубов øF	Ø отверстий øO	Ø по отверстиям øP	Ø под трубу	Каталожный номер
	30	113	34,6	28,3	30,5	10	95,4	---	CVJ012
	30	94	27	26,6	25	10	81	---	RV251
	30	94	27	---	---	8	80	47,6	RV251Y
	30	95	27	---	---	10	81	60,4	ME277Y
	32	100	28	27,2	26,8	10	86	---	BM725
	32	100	28	---	---	10	86	55,5	BM317Y
	32	100	35	34/39	26,9	8	86	---	VW704

Шрус карданного вала	Кол-во зубов If	Наружный диаметр ØD	Ширина шруса H	Величина на зуб Lf	Ø зубов øF	Ø отверстий øO	Ø по отверстиям øP	Ø под трубу	Каталожный номер
	32	100	35	34/39	26,7	8	86	---	VW704-E
	35	100	28,4	29	28,8	8	86	---	ME305-E
	35	124		25,1	29	10	107		FD861Y
	35	124	48,7	25,1	29	10	107	---	FD861